

SECTION I  
SPECIFICATIONS

PERFORMANCE

Performance figures are for airplanes equipped for cross-country transportation and flown at gross weight under standard conditions at sea level or stated altitude. Any changes in equipment may result in changes in performance.

Take-off Ground Run (S.L. Std., maximum effort, 25° flap) (ft)	720
Take-off over 50-ft Barrier S.L. Std., (maximum effort, 25° flap) (ft)	1625
Best Rate of Climb Speed (mph)	85
Rate of Climb (ft per min)	725
Service Ceiling (ft)	14,150
Absolute Ceiling (ft)	16,500
Top Speed (mph)	148
Optimum Cruise Speed (TAS) (75% power, optimum altitude, leaned to best power) (mph)	141
Cruising Range (75% power, optimum altitude leaned to best economy, no reserves or climb allowance) (mi)	686
Optimum Cruising Range (55% power, 10,000 ft, leaned to best economy, no reserves or climb allowance) (mi)	706
Stalling Speed CAS (flaps down) (mph)	61
Stalling Speed CAS (flaps up) (mph)	68
Landing Roll S.L. Std., (flaps down) (ft)	635*
Landing Roll over 50-ft Barrier S.L. Std., (ft)	1185*

\*This value applies only for the conditions indicated on the landing distance versus density altitude chart.

## SPECIFICATIONS (cont.)

## WEIGHTS

Gross Weight (lbs) 2450  
 Empty Weight (Standard) (lbs) 1384\*  
 USEFUL LOAD (Standard) (lbs) 1066\*

## POWER PLANT

Engine (Lycoming) O-360-A4A  
 Rated Horsepower 180  
 Rated Speed (rpm) 2700  
 Bore (in.) 5.125  
 Stroke (in.) 4.375  
 Displacement (cu in.) 361.0  
 Compression Ratio 8.5:1  
 Dry Weight (lbs) 285  
 Propeller 76EM855-0-60

## FUEL AND OIL

Fuel Capacity (U.S. gal) Usable 48  
 Oil Capacity (qts) 8  
 Fuel, Aviation Grade (min octane) 100/130

## BAGGAGE

Maximum Baggage (lbs) 200  
 Baggage Space (cu ft) 24  
 Baggage Door Size (in.) 20 x 22

Weight varies with each aircraft

761 513  
 720615

## CHEROKEE 180

## SECTION I

## SPECIFICATIONS (cont.)

## DIMENSIONS

Wing Span (ft) 32  
 Wing Area (sq ft) 170  
 Wing Loading (lbs per sq ft) 14.4  
 Length (ft) 24.0  
 Height (ft) 7.8  
 Power Loading (lbs per hp) 13.6

## LANDING GEAR

	Nose	Main
Wheel Base (ft)	6.7	
Wheel Tread (ft)	10	
Tire Pressure (psi)	24	24
Tire Size	Nose (4 ply rating) Main (4 ply rating)	6.00 x 6 6.00 x 6

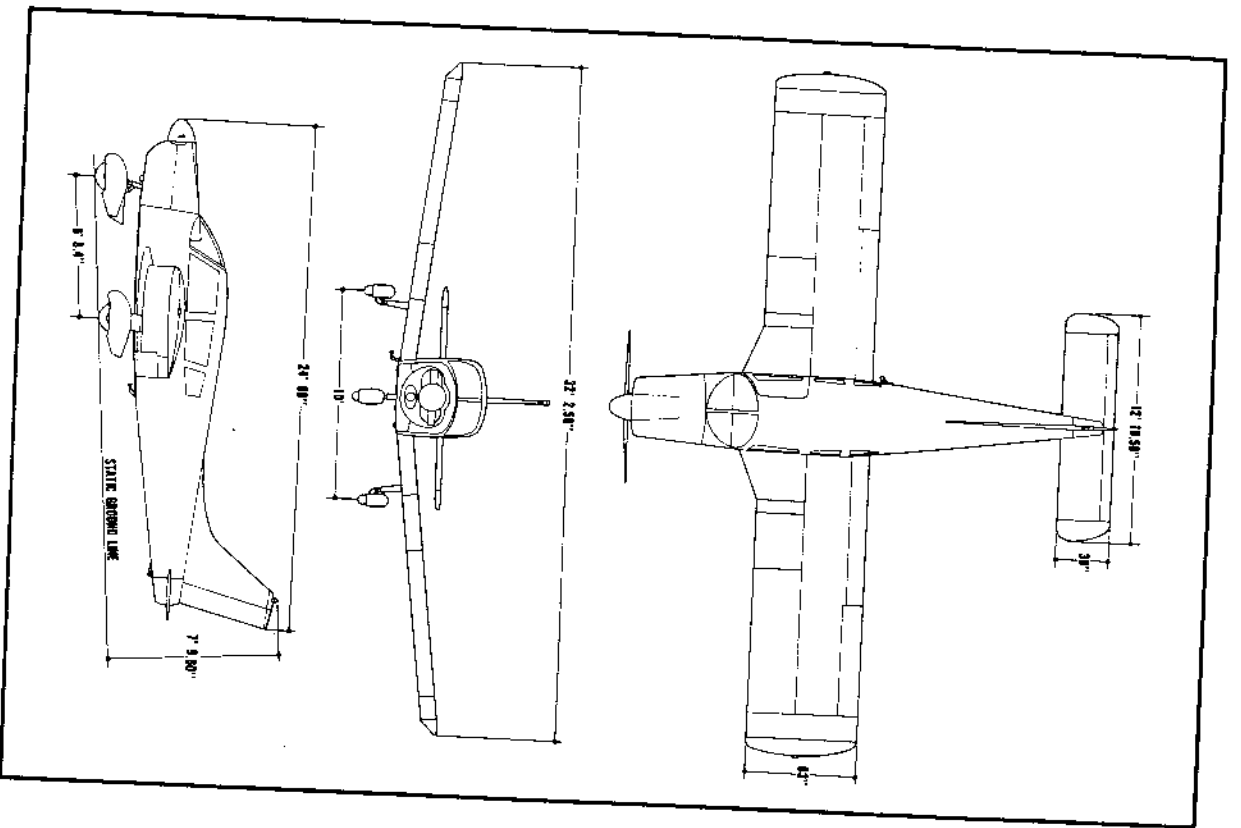

761 513  
720615

SECTION II

DESIGN INFORMATION

Engine and Propeller . . . . . 5

Structures . . . . . 5

Landing Gear . . . . . 6

Control Systems . . . . . 7

Fuel System . . . . . 7

Electrical System . . . . . 9

Hearing and Ventilating System . . . . . 13

Cabin Features . . . . . 13

Optional Equipment . . . . . 16

## SECTION II

## DESIGN INFORMATION

## ENGINE AND PROPELLER

The Cherokee 180 is powered by a Lycoming O-360-A4A four cylinder, direct drive, horizontally opposed engine rated at 180 HP at 2700 RPM. It is furnished with a starter, 60 ampere 12 volt alternator, shielded ignition, vacuum pump drive, fuel pump, and a dry, automotive type carburetor air filter.

The exhaust system is of the cross-over type to reduce back pressure and improve performance. It is made entirely from stainless steel and is equipped with dual mufflers. A heater shroud around the mufflers is provided to supply heat for the cabin and windshield defrosting.

The Sensenich 76EM855-0-60 fixed-pitch propeller is made from a one-piece alloy forging.

## STRUCTURES

All structures are of aluminum alloy construction and are designed to ultimate load factors well in excess of normal requirements. All exterior surfaces are primed with etching primer and painted with acrylic lacquer.

The wings are attached to each side of the fuselage by inserting the butt ends of the respective main spars into a spar box carry-through which is an integral part of the fuselage structure, providing in effect a continuous main spar with splices at each side of the fuselage. There are also fore and aft attachments at the rear spar and at an auxiliary front spar.

The wing airfoil section is a laminar flow type, NACA65<sub>2</sub>-415 with the maximum thickness about 40% aft of the leading edge. This permits the main spar carry-through structure to be located under the rear seat providing unobstructed cabin floor space ahead of the rear seat.

### LANDING GEAR

The three landing gears use a Cleveland 6.00 x 6 wheel, the main wheels being provided with Cleveland single disc hydraulic brake assemblies, No. 30-55. All wheels use 6.00 x 6 four ply tires with tubes.

The nose gear is steerable through a 44 degree arc by use of the rudder pedals. A spring device is incorporated in the rudder pedal torque tube assembly to aid in rudder centering and to provide rudder trim. The nose gear steering mechanism also incorporates a hydraulic shimmy damper.

The three struts are of the air-oil type, with the normal extension being 3.25 inches for the nose gear and 4.50 inches for the main gear.

The standard brake system for the Cherokee consists of a hand lever and master cylinder which is located below and behind the left center of the instrument sub-panel. The brake fluid reservoir is installed on the top left front face of the firewall. The parking brake is incorporated in the master cylinder and is actuated by pulling back on the brake lever, depressing the knob attached to the handle and releasing the brake lever. To release the parking brake, pull back on the lever to disengage the catch mechanism and allow the handle to swing forward.

Optional toe brakes are available to supplement the standard hand lever and parking brake system.

### CONTROL SYSTEMS

Dual controls are provided as standard equipment with a cable system used between the controls and the surfaces. The horizontal tail is of the Flying Tail type (stabilator), with a trim tab mounted on the trailing edge of the stabilator to reduce the control system forces. This tab is actuated by a control wheel on the floor between the front seats. The stabilator provides extra stability and controllability with less size, drag and weight than conventional tail surfaces. The ailerons are provided with a differential action which tends to reduce adverse yaw in turning maneuvers, and which also reduces the amount of coordination required in normal turns. A rudder trim adjustment is mounted on the right side of the pedestal below the throttle quadrant and permits directional trim as needed in flight.

The flaps are manually operated, balanced for light operating forces and spring-loaded to return to the up position. A past-center lock incorporated in the actuating linkage holds the flap when it is in the up position so that it may be used as a step on the right side. The flap will not support a step load except when in the full up position, so it must be completely retracted when used as a step. The flaps have three extended positions: 10, 25 and 40 degrees.

### FUEL SYSTEM

Fuel is stored in two twenty-five gallon (24 gal. usable) tanks which are secured to the leading edge structure of each wing by screws and nut plates. This allows easy removal for service or inspection.

The fuel selector control is located on the left side-panel, forward of the pilot's seat. The button on the selector must be depressed and held while the handle is moved to the OFF position. The button releases automatically when the handle is moved back into the ON position.

An auxiliary electric fuel pump is provided in case of failure of the engine driven pump. The electric pump should be on for all take-offs and landings, and when switching tanks. The pump switch is located in the switch panel above the throttle quadrant.

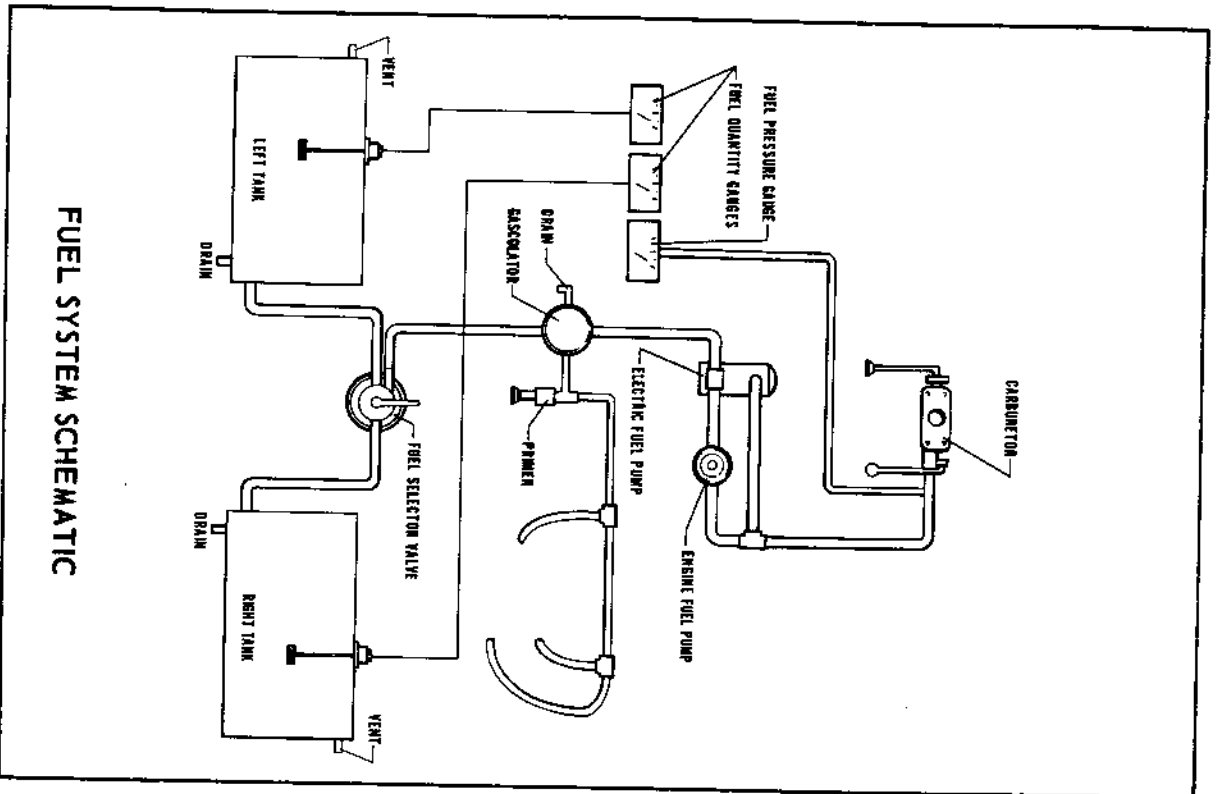

FUEL SYSTEM SCHEMATIC

## CHEROKEE 180

## SECTION II

Each tank has an individual quick drain located at the bottom, inboard rear corner, and should be drained to check for water before each flight. The fuel strainer, which is also equipped with a quick drain, is located on the front lower left corner of the firewall. This strainer should be drained regularly to check for water or sediment accumulation. To drain the lines from the tanks, the tank selector valve must be switched to each tank in turn, with the electric pump on, and the gascolator drain valve opened.

Fuel quantity and pressure are indicated on gauges located in a cluster on the left side of the instrument panel.

## ELECTRICAL SYSTEM

The electrical system includes a 12 volt 60 amp alternator, battery, voltage regulator, overvoltage relay and master switch relay. The battery is mounted in a stainless steel box immediately aft of the baggage compartment. The regulator and overvoltage relay are located on the forward left side of the fuselage behind the instrument panel.

Electrical switches are located on the right center instrument panel, and the circuit breakers are located on the lower right instrument panel. A rheostat-switch on the left side of the switch panel controls the navigation lights and the dome instrument light. It also dims the dome light. The similar switch on the right side controls and dims the panel lights.

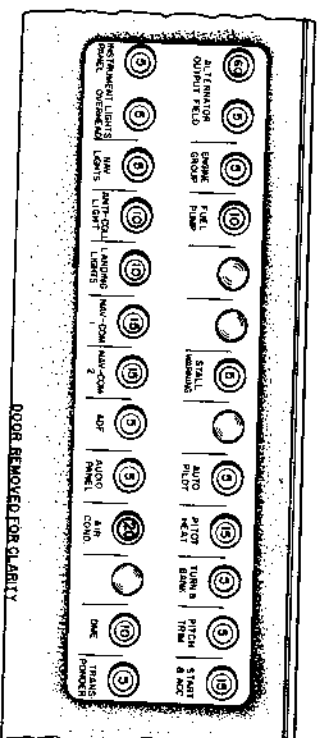

Circuit Breaker Panel

The alternator system offers many advantages over the generator system both in operation and maintenance. The main advantage is full electrical power output at lower engine RPM. This is a great improvement for radio and electrical equipment operation. Since the alternator output is available at all times, the battery will be charging for a greater percentage of use. This will make cold-morning starting easier.

Standard accessories include a starter, electric fuel pump, stall warning indicator, cigar lighter, fuel gauge and ammeter. The navigation lights, anti-collision light, landing light, instrument lighting and cabin dome light are optional. Circuits will handle an entire complement of communications and navigational equipment.

The words "master switch" used hereafter in this manual indicate both sides of the switch, battery side "BAT" and alternator side "ALT" are to be depressed simultaneously to OFF or ON as directed.

Unlike previous generator systems, the ammeter does not indicate battery discharge; rather it displays in amperes the load placed on the alternator. With all electrical equipment off (except master switch) the ammeter will be indicating the amount of charging current demanded by the battery. As each item of electrical equipment is turned on, the current will increase to a total appearing on the ammeter. This total includes the battery. The maximum continuous load for night flight, with radios on, is about 30 amperes. This 30 ampere value, plus approximately two amperes for a fully charged battery, will appear continuously under these flight conditions. The amount of current shown on the ammeter will tell immediately if the alternator system is operating normally, as the amount of current shown should equal the total amperage drawn by the equipment which is operating.

If no output is indicated on the ammeter during flight, reduce the electrical load by turning off all unnecessary electrical equipment. Check both 5 ampere field breaker and 60 ampere output breaker and reset if open. If neither circuit breaker is open, turn off the "ALT" switch for 30 seconds to reset the overvoltage relay. If ammeter continues to indicate no output, maintain minimum electrical load and terminate flight as soon as practical.

Maintenance on the alternator should prove to be a minor factor. Should service be required, contact the local Piper Dealer.

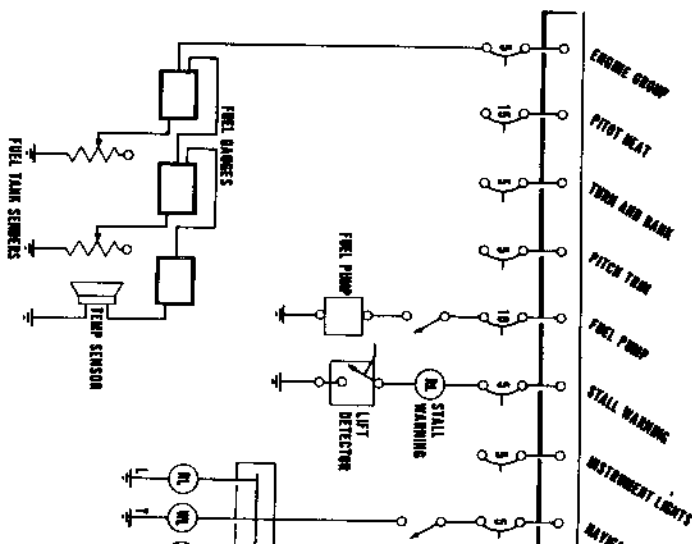

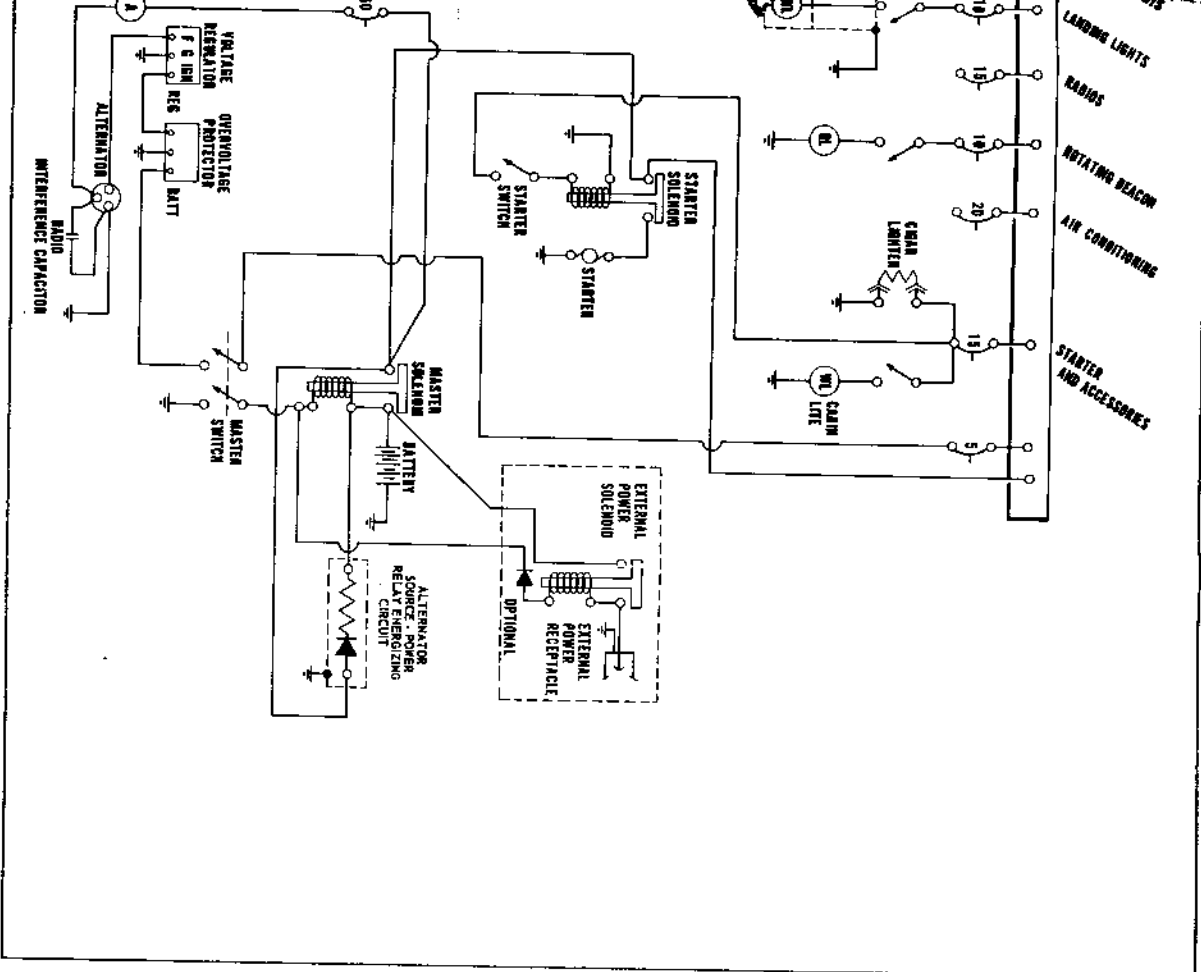

HEATING AND VENTILATING SYSTEM

Heat for the cabin interior and the defroster system is provided by a heater muff attached to the exhaust system. The amount of heat desired can be regulated with the controls located on the far right side of the instrument panel.

The air flow can be regulated between the front and rear seats by levers located on top of the heat ducts next to the console.

Fresh air inlets are located in the leading edge of the wing at the intersection of the tapered and straight sections. A large adjustable outlet is located on the side of the cabin near the floor at each seat location. Cabin air is exhausted through an outlet located below the rear seat.

CABIN FEATURES

The instrument panel of the Cherokee is designed to accommodate the customary advanced flight instruments and the normally required power plant instruments. The Artificial Horizon and Directional Gyro are vacuum operated through use of a vacuum pump installed on the engine, while the Turn and Bank instrument is electrically operated. A vacuum gauge is mounted on the far right side of the instrument panel.

A natural separation of the flight group and the power group is provided by placing the flight group in the upper instrument panel and the power group in the center and lower instrument panels. The radio and circuit breakers located on the right hand instrument panel have extra circuits provided for a complete line of optional radio equipment. The microphone is located on the control quadrant cover, see illustration page 14, item 42.

The cabin interior includes a pilot storm window, two sun visors, ash trays, two map pockets, and pockets on the backs of each front seat. The front seats are adjustable fore and aft for pilot-passenger comfort and ease of entry and exit. Arm rests are also provided for the front seats.



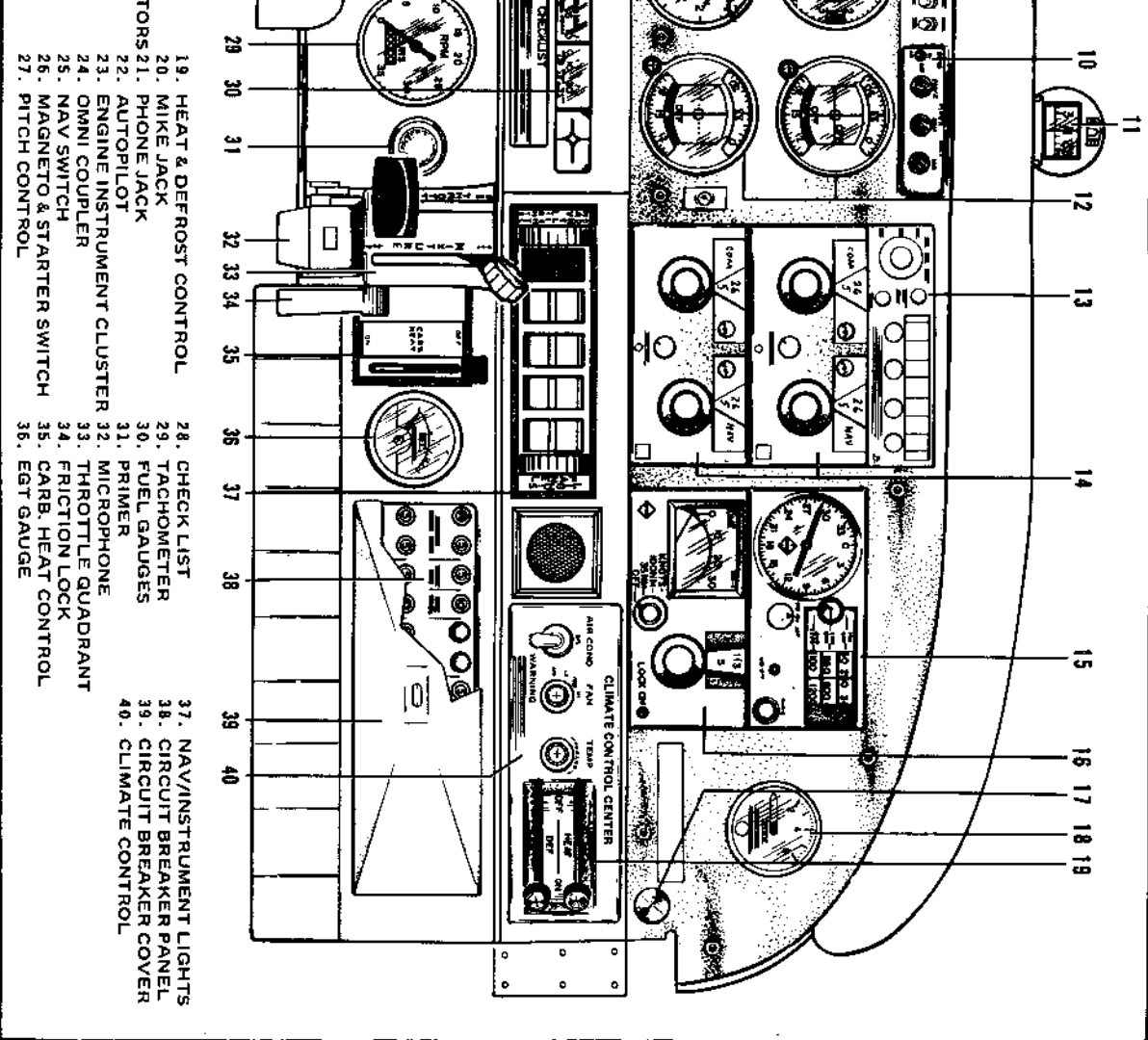

- 19. HEAT & DEFROST CONTROL
- 20. MIKE JACK
- 21. PHONE JACK
- 22. AUTOPILOT
- 23. ENGINE INSTRUMENT CLUSTER
- 24. OMNI COUPLER
- 25. NAV SWITCH
- 26. MAGNETO & STARTER SWITCH
- 27. PITCH CONTROL
- 28. CHECK LIST
- 29. TACHOMETER
- 30. FUEL GAUGES
- 31. PRIMER
- 32. MICROPHONE
- 33. THROTTLE QUADRANT
- 34. FRICTION LOCK
- 35. CARB. HEAT CONTROL
- 36. EGT GAUGE
- 37. NAV/INSTRUMENT LIGHTS
- 38. CIRCUIT BREAKER PANEL
- 39. CIRCUIT BREAKER COVER
- 40. CLIMATE CONTROL

761.513  
720615

CHEROKEE 180

SECTION II

A single strap shoulder harness controlled by an inertia reel is standard equipment for the front seats, and is offered as an option for the rear seats. The shoulder strap is routed over the shoulder adjacent to the windows and attached to the lap belt in the general area of the person's inboard hip.

A check of the inertia reel mechanism is made by pulling sharply on the strap. The reel will lock in place under this test and prevent the strap from extending. Under normal movement the strap will extend and retract as required.

The 24 cubic foot baggage area may be reached from the cabin or through a large 20 x 22 inch outside door.

**AIR CONDITIONING\***

The air conditioning system is a recirculating air system. The major items include: evaporator, condenser, compressor, blower, switches and temperature controls.

The evaporator is located behind the left rear side of the baggage compartment. This cools the air that is used for air conditioning.

The condenser is mounted on a retractable scoop located on the bottom of the fuselage and to the rear of the baggage compartment area. The scoop extends when the air conditioner is "ON" and retracts to a flush position when the system is "OFF."

The compressor is mounted on the forward right underside of the engine. It has an electric clutch which automatically engages or disengages the compressor to the belt drive system of the compressor.

An electrical blower is mounted on the aft side of the rear cabin panel. Air from the baggage area is drawn through the evaporator by the blower and distributed through an overhead duct to individual outlets located adjacent to each occupant.

The switches and temperature control are located on the lower right side of the instrument panel in the climate control center panel. The temperature control regulates the desired temperature of the cabin. Turn the control clockwise for increased cooling, counterclockwise for decreased cooling.

Located inboard of the temperature control is the fan speed switch and the air conditioning "ON-OFF" switch. The fan can be operated independently of the air conditioning. However, it must be on for air conditioner operation. Turning either switch off will disengage the compressor clutch and retract the condenser door. Cooling air should be felt within one minute after the air conditioner is turned on.

\*Optional Equipment

## CHEROKEE 180

## SECTION II

**NOTE**

If the system is not operating in 5 minutes turn the system "OFF" until the fault is corrected.

The "FAN" switch allows operation of the fan with the air conditioner turned "OFF" to aid cabin air circulation if desired. A "LOW," "MED" or "HIGH" flow of air can be selected to the air conditioner outlets located in the overhead duct. The outlets can be adjusted or turned off by each occupant to obtain individual cooling effect.

The "DOOR OPEN" indicator light is located to the left of the radio stack in front of the pilot. The light illuminates whenever the condenser door is open and remains on until the door is closed.

A circuit breaker located on the circuit breaker panel protects the air conditioning electrical system.

Whenever the throttle is in the full throttle position, it actuates a micro switch which disengages the compressor and retracts the scoop. This is done to obtain maximum power and maximum rate of climb. The fan continues to operate and the air will remain cool for approximately one minute. When the throttle is retarded approximately 1/4 inch, the clutch will engage and the scoop will extend, again supplying cool, dry air.

NOTES

SECTION III

OPERATING INSTRUCTIONS

Preflight . . . . . 19

Starting Engine . . . . . 20

Warm-Up and Ground Check . . . . . 22

Take-Off . . . . . 23

Climb . . . . . 23

Stalls . . . . . 24

Cruising . . . . . 24

Approach and Landing . . . . . 25

Stopping Engine . . . . . 26

Engine Power Loss . . . . . 26

Mooring . . . . . 27

Weight and Balance . . . . . 27

Operating Tips . . . . . 27

Optional Equipment . . . . . 30

SECTION III

OPERATING INSTRUCTIONS

PREFLIGHT

1. Master switch and ignition OFF.
2. 4. Check for external damage and operational interference of control surfaces or hinges.
  - b. Insure that wings and control surfaces are free of snow, ice or frost.
3. a. Visually check fuel supply and secure caps.
  - b. Drain fuel tank sumps (two).

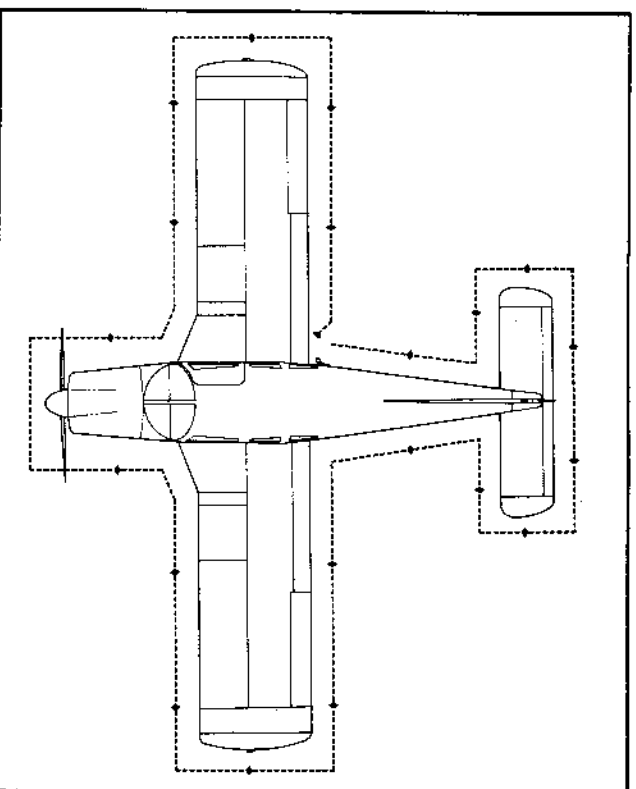

- c. Drain fuel system sump (left side of aircraft).
- d. Check that fuel system vents are open.
- e. Check main landing gear shock struts for proper inflation (approximately 4.50 inches showing).

- f. Check tires for cuts, wear and proper inflation.
- g. Check brake blocks and discs for wear and damage.
4. Check windshield for cleanliness.
  - a. Check propeller and spinner for defects or nicks.
  - b. Check for obvious fuel or oil leaks.
  - c. Check oil level (insure dipstick is properly seated).
  - d. Check cowling and inspection covers for security.
  - e. Check nose wheel tire for inflation and wear.
  - f. Check nose gear shock strut for proper inflation (approximately 3.25 inches showing).
  - g. Check for foreign matter in air inlet.
  - h. Stow tow-bar and control locks if used.
  5. Check baggage for storage and security.
    - a. Close and secure the baggage compartment door.
    6. Upon entering airplane remove seat belt securing control wheel. Check that all primary flight controls operate properly.
      - a. Close and secure cabin door.
      - b. Check that required papers are in order and in the airplane.
      - d. Fasten seat belts and shoulder harness. Check function of inertia reel.

#### STARTING ENGINE

1. Set parking brake ON.
2. Set the carburetor heat control in the full COLD position.
3. Select the desired tank with fuel selector valve.

#### Starting Engine When Cold:

1. Open throttle approximately 1/4 inch.
2. Turn the master switch ON.
3. Turn the electric fuel pump ON.
4. Move the mixture control to FULL RICH.
5. Engage the starter by rotating magneto switch clockwise and pressing in.

20

761 513  
730122

6. When the engine fires, advance throttle to desired setting. If the engine does not fire within five to ten seconds, disengage starter and prime with one to three strokes of the priming pump. Repeat the starting procedure.

#### Starting Engine When Hot:

1. Open the throttle approximately 1/2 inch.
2. Turn the master switch ON.
3. Turn the electric fuel pump ON.
4. Put mixture control in IDLE CUT-OFF.
5. Engage the starter by rotating magneto switch clockwise and pressing in. When the engine fires, advance the mixture control and move the throttle to desired setting.

#### Starting Engine When Flooded:

1. Open the throttle full.
2. Turn the master switch ON.
3. Turn the electric fuel pump OFF.
4. Put mixture control in IDLE CUT-OFF.
5. Engage the starter by rotating magneto switch clockwise and pressing in. When the engine fires, advance the mixture control and retard the throttle.

#### Starting With External Power Source:

An optional feature known as Piper External Power (PEP) allows the operator to use an external battery to crank the engine without having to gain access to the aircraft battery.

The procedure is as follows:

1. Turn aircraft MASTER SWITCH to OFF.
2. Connect RED lead of PEP kit jumper cable to POSITIVE (+) terminal of external 12 volt battery and BLACK lead to NEGATIVE (-) terminal.
3. Insert plug of jumper cable into socket located on aircraft fuselage.
4. Turn aircraft MASTER SWITCH to ON and proceed with NORMAL engine starting technique.

761 513  
720615

21

5. After engine has been started, turn MASTER SWITCH to OFF and remove jumper cable plug from aircraft.
6. Turn aircraft MASTER SWITCH to ON and check alternator ammeter for indication of output. DO NOT ATTEMPT FLIGHT IF THERE IS NO INDICATION OF ALTERNATOR OUTPUT.

When the engine is firing evenly, advance the throttle to 800 RPM. If oil pressure is not indicated within thirty seconds, stop the engine and determine the trouble. In cold weather it will take a few seconds longer to get an oil pressure indication. If the engine has failed to start, refer to the "Lycoming Operating Handbook, Engine Troubles and Their Remedies."

Starter manufacturers recommend that cranking periods be limited to thirty seconds with a two minute rest between cranking periods. Longer cranking periods will shorten the life of the starter.

#### WARM-UP AND GROUND CHECK

Warm-up the engine at 800 to 1200 RPM for not more than two minutes in warm weather, four minutes in cold weather. Avoid prolonged idling at low RPM as this practice may result in fouled spark plugs. If necessary to hold before take-off, it is recommended that the engine be idled at 1200 RPM.

The magnetos should be checked at 2000 RPM and the drop off on either magneto should not exceed 175 RPM and should be within 50 RPM of the other. Prolonged operation on one magneto should be avoided.

Check vacuum gauge, indicator should read 5" Hg ± .1" Hg at 2000 RPM.

Check both the oil temperature and pressure. The temperature may be low for some time if the engine is being run for the first time of the day, but as long as the pressure is within limits the engine is ready for take-off.

Carburetor heat should also be checked prior to take-off to be sure that the control is operating properly and to clear any ice which may have formed during taxiing. Avoid prolonged ground operation with carburetor heat ON as the air is unfiltered.

22

761 513  
730122

Operation of the engine driven fuel pump should be checked while taxiing or during pretake-off engine run up by switching off the electric fuel pump and observing fuel pressure. The electric fuel pump should be on during take-off to prevent loss of power should the engine driven pump fail. The engine is warm enough for take-off when the throttle can be opened without the engine faltering. For air conditioner ground check refer to page 30.

#### TAKE-OFF

Just before take-off the following items should be checked:

- |                            |                           |
|----------------------------|---------------------------|
| 1. Fuel on proper tank     | 7. Seat backs erect       |
| 2. Electric fuel pump - on | 8. Fasten belts/harness   |
| 3. Engine gauges checked   | 9. Trim tab - set         |
| 4. Flaps - set             | 10. Controls - free       |
| 5. Carb. heat off          | 11. Door - latched        |
| 6. Mixture - set           | 12. Air conditioner - off |

The take-off technique is conventional for the Cherokee. The tab should be set slightly aft of neutral, with the exact setting determined by the loading of the aircraft. Allow the airplane to accelerate to 50 to 60 MPH, then ease back on the wheel enough to let the airplane fly itself off the ground. Premature raising of the nose, or raising it to an excessive angle will result in a delayed take-off. After take-off let the aircraft accelerate to the desired climb speed by lowering the nose slightly.

Take-offs are normally made with flaps up. However, for short field take-offs, and for take-offs under difficult conditions such as deep grass or on a soft surface, distances can be reduced appreciably by lowering flaps to 25°.

#### CLIMB

The best rate of climb at gross weight will be obtained at 85 MPH. The best angle of climb may be obtained at 74 MPH. At lighter than gross weight these speeds are reduced somewhat. For climbing en route a speed of 100 MPH is recommended. This will produce better forward speed and increased visibility over the nose during the climb. The air conditioner may be turned on after all obstacles have been cleared.

761 513  
730122

23

## STALLS

All controls are effective at speeds down through the stalling speed, and stalls are gentle and easily controlled.

Stall speed chart on following page is at gross weight. Stall speeds at lower weights will be correspondingly less.

STALL SPEED TABLE

Angle of Bank	Flaps 40°	Flaps Retracted
0°	61 MPH	68 MPH
20°	63 MPH	70 MPH
40°	70 MPH	78 MPH
60°	86 MPH	96 MPH

Power Off - Gross Weight 2450 lbs.

## CRUISING

The cruising speed is determined by many factors including power setting, altitude, temperature, loading and equipment installed on the airplane.

The normal cruising power is 75% of the rated horsepower of the engine. True airspeeds which may be obtained at various altitudes and power settings can be determined from the charts in Section IV of this handbook.

Use of the mixture control in cruising flight reduces fuel consumption significantly, especially at higher altitudes. The mixture should be leaned during cruising operation above 5000 feet altitude and at pilot's discretion at lower altitudes when 75% power or less is being used. If any doubt exists as to the amount of power being used, the mixture should be in the FULL RICH position for all operations under 5000 feet.

## CHEROKEE 180

## SECTION III

To lean the mixture, pull the mixture control until the engine becomes rough, indicating that the lean mixture limit has been reached in the leaner cylinders. Then enrich the mixture by pushing the control towards the instrument panel until engine operation becomes smooth.

If the airplane is equipped with the optional exhaust gas temperature (EGT) gauge, a more accurate means of leaning is available to the pilot. For this procedure, refer to the AVCO Lycoming Operator's Manual.

In order to keep the airplane in best lateral trim during cruising flight, the fuel should be used alternately from each tank. It is recommended that one tank be used for one hour after take-off, then the other tank be used for two hours, then return to the first tank, which will have approximately one and one half hours of fuel remaining if the tanks were full at take-off. The second tank will contain approximately one half hour of fuel. Do not run tanks completely dry in flight.

## APPROACH AND LANDING

Before landing check list:

1. Fuel on proper tank
2. Mixture - rich
3. Electric fuel pump - on
4. Seat backs erect
5. Flaps - set (115 MPH)
6. Fasten belts/harness
7. Air conditioner - off

The airplane should be trimmed to an approach speed of about 85 MPH with flaps up. The flaps can be lowered at speeds up to 115 MPH, if desired, and the approach speed reduced 3 MPH for each additional notch of flaps. Carburetor heat should not be applied unless there is an indication of carburetor icing, since the use of carburetor heat causes a reduction in power which may be critical in case of a go-around. Full throttle operation with heat on is likely to cause detonation.

The amount of flap used during landings and speed of the aircraft at contact with the runway should be varied according to the landing surface and conditions of wind and airplane loading. It is generally good practice to contact the ground at minimum possible safe speed consistent with existing conditions.

Normally, the best technique for short and slow landings is to use full flap and enough power to maintain the desired airspeed and approach flight path. Reduce the airspeed during flare out and contact the ground close to stalling speed. After ground contact hold the nose wheel off as long as possible. As the airplane slows down, drop the nose and apply brakes. There will be less chance of skidding the tires if the flaps are retracted before applying the brakes. Braking is most effective when back pressure is applied to the control wheel, putting most of the airplane weight on the main wheels. In high wind conditions, particularly in strong crosswinds, it may be desirable to approach the ground at higher than normal speeds with partial or no flaps.

### STOPPING ENGINE

At the pilot's discretion, the flaps should be raised and the electric fuel pump turned off. After parking, the air conditioner and radios should be turned off and the engine stopped by pulling the mixture control to idle cut-off. The throttle should be left full aft to avoid engine vibration while stopping. Then the magneto and master switches should be turned off and the parking brake set.

### ENGINE POWER LOSS

The most common cause of engine power loss is mismanagement of the fuel. Therefore, the first step to take after engine power loss is to move the fuel selector valve to the tank not being used. This will often keep the engine running even if there is no apparent reason for the engine to stop on the tank being used.

If changing to another tank does not restore the engine:

1. Check fuel pressure and turn on electric fuel pump if off.
2. Push mixture control to full "RICH."
3. Check ignition switch. Turn to best operating magneto - left, right, or both.

### MOORING

The Cherokee should be moved on the ground with the aid of the nose wheel tow-bar provided with each plane and secured in the baggage compartment. Tie down ropes may be secured to rings provided under each wing and to the tail skid. The aileron and stabilator controls should be secured by looping the seat belt through the control wheel and pulling it tight. The rudder is held in position by its connections to the nose wheel steering and normally does not have to be secured. The flaps are locked when in the full up position and should be left retracted.

### WEIGHT AND BALANCE

It is the responsibility of the owner and pilot to determine that the airplane remains within the allowable weight vs. center of gravity envelope while in flight. For weight and balance data see the Airplane Flight Manual and Weight and Balance form supplied with each airplane.

### OPERATING TIPS

The following Operating Tips are of particular value in the operation of the Cherokee.

1. Learn to trim for take-off so that only a very light back pressure on the wheel is required to lift the airplane off the ground.
2. The best speed for take-off is about 60 MPH under normal conditions. Trying to pull the airplane off the ground at too low an airspeed decreases the controllability of the airplane in event of engine failure.
3. Flaps may be lowered at airspeeds up to 115 MPH. To reduce flap operating loads, it is desirable to have the airplane at a slower speed before extending the flaps.
4. Before attempting to reset any circuit breaker, allow a two to five minute cooling off period.



5. Before starting the engine, check that all radio switches, light switches, and the pitot heat switch are in the off position so as not to create an overloaded condition when the starter is engaged.
6. The overvoltage relay is provided to protect the electronics equipment from a momentary overvoltage condition (approximately 16.5 volts and up), or a catastrophic regulator failure. In the event of a momentary condition, the relay will open and the ammeter will indicate "0" output from the alternator. The relay may be reset by switching the "ALT" switch to "OFF" for approximately 30 seconds and then returning the "ALT" switch to "ON."
7. The vacuum gauge is provided to monitor the pressure available to assure the correct operating speed of the vacuum driven gyroscopic flight instruments, it also monitors the condition of the common air filter by measuring the flow of air thru the filter.

If the vacuum gauge registers lower than 5"  $\pm$  .10" Hg at 2000 RPM, the following items should be checked before flight:

- a. Common air filter, could be dirty or restricted.
- b. Vacuum lines could be collapsed or broken.
- c. Vacuum pump, worn.
- d. Vacuum regulator, not adjusted correctly. The pressure, even though set correctly, can read lower under two conditions: (1) Very high altitude, above 12000 feet, (2) Low engine RPM usually on approach or during training maneuvers. This is normal and should not be considered a malfunction.

#### PIPER AUTOMATIC LOCATOR

The Piper Automatic Locator, when installed, is located in the aft portion of the fuselage just below the stabilator leading edge and is accessible through a plate on the right side of the fuselage. It is an emergency locator transmitter which meets the requirements of FAR 91.52. It is automatically activated by a longitudinal force of 5 to 7 g's and transmits a distress signal on both 121.5 MHz and 243.0 MHz for a period of 48 hours in low temperature areas to 100 hours in high temperature areas. The unit operates on a self contained battery.

The battery has a useful life of four years. However, to comply with FAA regulations, it must be replaced after two years of shelf life or service life. The battery should also be replaced if the transmitter has been used in an emergency situation or if the accumulated test time

28

761 513  
730122

exceeds one hour. The replacement date is marked on the transmitter label.

The unit has a three position selector switch placarded "OFF," "ARM" and "ON." The "ARM" position is provided to set the unit to the automatic position so that it will transmit only after impact and continue to transmit until the battery power is drained to depletion or the switch is manually moved to the "OFF" position. The "ARM" position is selected when the locator is installed at the factory and should remain in that position whenever the unit is installed in the aircraft. The "ON" position is provided so the unit can be used as a portable transmitter or in the event the automatic feature was not triggered by impact or to check the function of the transmitter periodically.

The "OFF" position is provided for the purpose of changing the battery or if used as a portable transmitter or rearming the unit if it should be activated for any reason.

#### NOTE

If the switch has been placed in the "ON" position for any reason, the "OFF" position has to be selected before selecting "ARM." If "ARM" is selected directly from the "ON" position the transmitter will continue to transmit in the "ARM" position.

Attached to the unit is a portable antenna, provided so that the locator may be removed from the aircraft, in case of an emergency, and used as a portable signal transmitter.

The locator should be checked during the Ground Check to make certain the unit has not been accidentally activated. Check by tuning a radio receiver to 121.5 MHz. If you hear an oscillating audio sound the locator may have been activated and should be turned off immediately. Reset to "ARM" position and check again to insure against outside interference.

761 513  
730122

29

## OPTIONAL EQUIPMENT

## AIR CONDITIONING

To operate the air conditioning system either on the ground or in flight:

1. Start the engine (ground operation).
2. Turn the air conditioning "Master" switch to "ON."
3. Turn "TEMP" control to desired temperature. Clockwise rotation increases cooling.
4. Select desired "FAN" position, "LOW," "MED" or "HIGH."

## AIR CONDITIONER OPERATIONAL CHECK PROCEDURE

Prior to take-off the air conditioner should be checked for proper operation as follows:

1. Check aircraft Master Switch ON.
2. Select desired "FAN" position, "LOW," "MED" or "HIGH."
3. Turn the air conditioner control switch to "ON" - the "Air Cond. Door Open" warning light will turn on, thereby indicating proper air conditioner condenser door actuation.
4. Turn the air conditioner control switch to "OFF" - the "Air Cond. Door Open" warning light will go out, thereby indicating the air conditioner condenser door is in the up position.
5. If the "Air Cond. Door Open" light does not respond as specified above, an air conditioner system or indicator bulb malfunction is indicated, and further investigation should be conducted prior to flight.

The above operational check may be performed during flight if an inflight failure is suspected.

## AIR CONDITIONER EFFECTS ON AIRPLANE PERFORMANCE

Operation of the air conditioner will cause slight decreases in the cruise speed and range of the Cherokee 180. Power from the engine is required to run the compressor, and the condenser door, when extended, causes a slight increase in drag. When the air conditioner is turned off there is normally no measurable difference in climb, cruise or range performance of the airplane.

## NOTE

To insure maximum climb performance the air conditioner must be turned off manually before take-off to disengage the compressor and retract the condenser door. Also the air conditioner must be turned off manually before the landing approach in preparation for a possible go-around.

Although the cruise speed and range are only slightly affected by the air conditioner operation, these changes should be considered in preflight planning. To be conservative, the following figures assume that the compressor is operating continuously while the airplane is airborne. This will be the case only in extremely hot weather.

1. The decrease in true airspeed is approximately 5 mph at all power settings.
2. The decrease in range may be as much as 37 statute miles for the 50 gal. capacity.

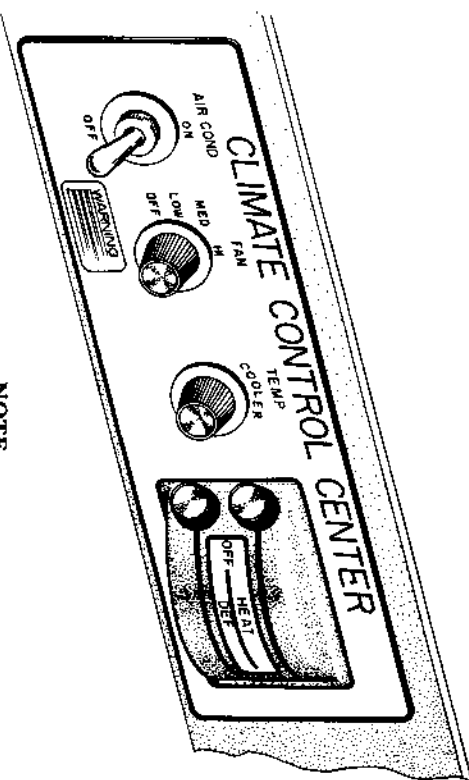

NOTE

To read power from the Power vs. Density Altitude Chart in this manual, add 50 rpm to the value observed on the tachometer when the air conditioner is operating.

The climb performance of Cherokee 180 is not compromised measurably with the air conditioner operating since the compressor is de-clutched and the condenser door is retracted, both automatically, when a full throttle position is selected. When the full throttle position is not used or in the event of a malfunction which caused the compressor to operate and the condenser door to be extended, a decrease in rate of climb of as much as 100 fpm can be expected. Should a malfunction occur which prevents condenser door retraction when the compressor is turned off, a decrease in rate of climb of as much as 50 fpm can be expected.

SECTION IV

EMERGENCY PROCEDURES

Introduction .....	33
Ground Operations .....	33
Take-Off .....	34
In Flight .....	35
Power Off Landing .....	36
Fire .....	37
Loss of Oil Pressure .....	37
Loss of Fuel Pressure .....	38
High Oil Temperature .....	38
Alternator Failure .....	38
Engine Roughness .....	38
Spins .....	40
Open Door .....	40

## SECTION IV

### EMERGENCY PROCEDURES

#### INTRODUCTION

This section contains procedures that are recommended if an emergency condition should occur during ground operation, take-off, or in flight. These procedures are suggested as the best course of action for coping with the particular condition described, but are not a substitute for sound judgement and common sense. Since emergencies rarely happen in modern aircraft, their occurrence is usually unexpected, and the best corrective action may not always be obvious. Pilots should familiarize themselves with the procedures given in this section and be prepared to take appropriate action should an emergency arise.

Most basic emergency procedures, such as power off landings, are a part of normal pilot training. Although these emergencies are discussed herein, this information is not intended to replace such training, but only to provide a source of reference and review, and to provide information on procedures which are not the same for all aircraft. It is suggested that the pilots review standard emergency procedures periodically to remain proficient in them.

#### GROUND OPERATIONS

##### ENGINE FIRE DURING START

Engine fires during start are usually the result of over priming. The procedures below are designed to draw the excess fuel back into the induction system:

1. If engine has not started:
  - a. Mixture - Idle cut-off
  - b. Throttle - Open
  - c. Turn engine with starter (This is an attempt to pull the fire into the engine.)
2. If engine has already started and is running, continue operating to try pulling the fire into the engine.

SECTION IV

CHEROKEE 180

3. In either case stated in (1) and (2), if the fire continues longer than a few seconds, the fire should be extinguished by the best available external means.

4. If external fire extinguishing is to be applied:
  - a. Fuel Selector Valves - Off
  - b. Mixture - Idle cut-off

TAKE-OFF

ENGINE POWER LOSS DURING TAKE-OFF

The proper action to be taken if loss of power occurs during take-off will depend on circumstances.

1. If sufficient runway remains for a normal landing, land straight ahead.
2. If insufficient runway remains, maintain a same airspeed and make only a shallow turn to avoid obstructions. Use of flaps depends on circumstances. Normally, flaps should be fully extended for touchdown.
3. If you have gained sufficient altitude to attempt a restart, proceed as follows:
  - a. MAINTAIN SAFE AIRSPEED
  - b. FUEL SELECTOR - SWITCH TO ANOTHER TANK CONTAINING FUEL
  - c. ELECTRIC FUEL PUMP - CHECK ON
  - d. MIXTURE - CHECK RICH
  - e. CARBURETOR HEAT - ON

NOTE

If engine failure was caused by fuel exhaustion, power will not be regained after tanks are switched until empty fuel lines are filled, which may require up to ten seconds.

If power is not regained, proceed with the POWER OFF LANDING procedure.

IN FLIGHT

ENGINE POWER LOSS IN-FLIGHT

Complete engine power loss is usually caused by fuel flow interruption, and power will be restored shortly after fuel flow is restored. If power loss occurs at low altitude, the first step is to prepare for an emergency landing. (See POWER OFF LANDING.) Maintain an airspeed of at least 80 MPH IAS, and if altitude permits, proceed as follows:

1. Fuel Selector - switch to another tank containing fuel.
2. Electric Fuel Pump - On
3. Mixture - Rich
4. Carburetor Heat - On
5. Engine Gauges - check for an indication of the cause of Power Loss.
6. Primer - Check Locked
7. If no fuel pressure is indicated, check tank selector position to be sure it is on a tank containing fuel.

When Power is Restored:

8. Carburetor Heat - Off
9. Electric Fuel Pump - Off

If the above steps do not restore power, prepare for an emergency landing. If time permits:

1. Ignition Switch - "L" then "R" then back to "BOTH".
2. Throttle and Mixture - Different settings. (This may restore power if problem is too rich or too lean a mixture, or partial fuel system restriction).
3. Try another fuel tank - (Water in the fuel could take some time to be used up, and allowing the engine to windmill may restore power. If power loss is due to water, fuel pressure indications will be normal).

761 513  
720615

761 513  
720615

## SECTION IV

## CHEROKEE 180

## FIRE

The presence of fire is noted through smoke, smell, and heat in the cabin. It is essential that the source of the fire be promptly identified through instrument readings, character of the smoke, or other indications, since the action to be taken differs somewhat in each case.

**Source of fire - Check**

1. Electrical Fire (smoke in cabin):
  - a. Master Switch - Off
  - b. Vents - Open
  - c. Cabin Heat - Off
  - d. Land as soon as possible.
2. Engine Fire
  - a. Fuel Selector - Off
  - b. Throttle - Closed
  - c. Mixture - Idle cut-off
  - d. Heater - Off (In all cases of fire)
  - e. Defroster - Off (In all cases of fire)
  - f. If terrain permits, land immediately.

The possibility of an engine fire in flight is extremely remote. The procedure given above is general and pilot judgment should be the deciding factor for action in such an emergency.

**LOSS OF OIL PRESSURE**

Loss of oil pressure may be either partial or complete. A partial loss of oil pressure usually indicates a malfunction in the oil pressure regulating system, and a landing should be made as soon as possible to investigate the cause, and prevent engine damage.

A complete loss of oil pressure indication may signify oil exhaustion or may be the result of a faulty gauge. In either case, proceed toward the nearest airport, and be prepared for a forced landing. If the problem is not a pressure gauge malfunction, the engine

## NOTE

If engine failure was caused by fuel exhaustion, power will not be regained after tanks are switched until empty fuel lines are filled, which may require up to ten seconds.

If power is not restored, proceed with **POWER OFF LANDING** procedures.

**POWER OFF LANDING**

If loss of power occurs at altitude, trim the aircraft for best gliding angle (80 MPH IAS) (Air Cond. Off) and look for a suitable field. If measures taken to restore power are not effective, and if time permits, check your charts for airports in the immediate vicinity; it may be possible to land at one if you have sufficient altitude. If possible, notify the FAA by radio of your difficulty and intentions. If another pilot or passenger is aboard, let them help.

When you have located a suitable field, establish a spiral pattern around this field. Try to be at 1000 feet above the field at the downwind position, to make a normal approach. Excess altitude may be lost by widening your pattern, using flaps or slipping, or a combination of these.

Touchdowns should normally be made at the lowest possible airspeed, with full flaps.

When committed to landing:

1. Ignition - Off
2. Master Switch - Off
3. Fuel Selector - Off
4. Mixture - Idle Cut-Off
5. Seat belt and harness - Tight

761 513  
720615

37

## SECTION IV

### CHEROKEE 180

may stop suddenly. Maintain altitude until such time as a dead stick landing can be accomplished. Don't change power settings unnecessarily, as this may hasten complete power loss.

Depending on the circumstances, it may be advisable to make an off airport landing while power is still available, particularly if other indications of actual oil pressure loss, such as sudden increase in temperatures, or oil smoke, are apparent, and an airport is not close.

If engine stoppage occurs, proceed to **POWER OFF LANDING**.

#### LOSS OF FUEL PRESSURE

1. Electric boost pump - On
2. Fuel Selector - Check on Full Tank

If problem is not an empty fuel tank, land as soon as practicable, and have engine driven fuel pump checked.

#### HIGH OIL TEMPERATURE

An abnormally high oil temperature indication may be caused by a low oil level, an obstruction in the oil cooler, damaged or improper baffle seals, a defective gauge, or other causes. Land as soon as practicable at an appropriate airport and have the cause investigated.

A steady rapid rise in oil temperature is a sign of trouble. Land at the nearest airport and let a mechanic investigate the problem. Watch the oil pressure gauge for an accompanying loss of pressure.

#### ALTERNATOR FAILURE

Loss of alternator output is detected through a zero reading on the ammeter. Before executing the following procedure, insure that the reading is zero and not merely low by actuating an electrically powered device, such as the landing light. If no increase in the ammeter reading is noted, alternator failure can be assumed.

## CHEROKEE 180

## SECTION IV

1. Reduce electrical load.
2. Alternator circuit breakers - Check
3. "Alt" switch - Off (for 30 seconds), Then On.

If the ammeter continues to indicate no output, or alternator will not stay reset, turn off "Alt" switch, maintain minimum electrical load and land as soon as practical. All electrical load is being supplied by the battery.

#### ENGINE ROUGHNESS

Engine roughness is usually due to carburetor icing which is indicated by a drop in RPM, and may be accompanied by a slight loss of airspeed or altitude. If too much ice is allowed to accumulate, restoration of full power may not be possible; therefore, prompt action is required.

1. Carburetor heat-on (See Note). RPM will decrease slightly and roughness will increase. Wait for a decrease in engine roughness or an increase in RPM, indicating ice removal. If no change in approximately one minute, return carburetor heat to **COLD**. If the engine is still rough, try steps below.
  - a. Mixture - Adjust for maximum smoothness. Engine will run rough if too rich or too lean.
  - b. Electric Fuel Pump - On
  - c. Fuel Selector - Change to other tank to see if fuel contamination is the problem.
  - d. Engine Gauges - Check for abnormal readings. If any gauge readings are abnormal, proceed accordingly.
  - e. Magneto Switch - "L" then "R", then back to "BOTH". If operation is satisfactory on either magneto, proceed on that magneto at reduced power, with mixture full rich, to a landing at the first available airport.

If roughness persists, prepare for a precautionary landing at pilot's discretion.

761 513  
720615

39

SECTION IV

CHEROKEE 180

NOTE

Partial carburetor heat may be worse than no heat at all, since it may partially melt ice, which will refreeze in the intake system. When using carburetor heat, therefore, always use full heat, and when ice is removed return the control to the full cold position.

- 3. Storm Window - Open
- 4. If upper latch is open - latch. If lower latch is open - open top latch, push door further open, and then close rapidly. Latch top latch.

A slip in the direction of the open door will assist in latching procedure.

SPINS

Intentional spins are prohibited in both the normal and the utility category airplane. For approved maneuvers as a utility category airplane, refer to the Flight Manual. Use the following procedure to recover from inadvertent spins.

- 1. THROTTLE - IDLE
- 2. RUDDER - FULL OPPOSITE TO DIRECTION OF ROTATION
- 3. CONTROL WHEEL - FULL FORWARD
- 4. RUDDER - NEUTRAL (WHEN ROTATION STOPS)
- 5. CONTROL WHEEL - AS REQUIRED TO SMOOTHLY REGAIN LEVEL FLIGHT ATTITUDE.

OPEN DOOR

The cabin door on the Cherokee is double latched, so the chances of it springing open in flight at both the top and bottom are remote. However, should you forget the upper latch, or not fully engage the lower latch, the door may spring partially open. This will usually happen at take-off or soon afterward. An open door will not affect normal flight characteristics, and a normal landing can be made with the door open.

If both upper and lower latches open, the door will trail slightly open, and airspeed will be reduced slightly.

To close the door in flight, proceed as follows:

- 1. Slow aircraft to 100 MPH IAS.
- 2. Cabin Vents - Close

761 513  
720615

761 513  
720615



NOTES

SECTION V  
PERFORMANCE CHARTS

Take-off Distance vs Density Altitude . . . . . 43

Altitude Conversion Chart . . . . . 44

Rate of Climb vs Density Altitude . . . . . 45

Range vs Density Altitude . . . . . 46

True Airspeed vs Density Altitude . . . . . 47

RPM vs Density Altitude . . . . . 48

Landing Distance vs Density Altitude . . . . . 49

# PA-28-180 PIPER CHEROKEE

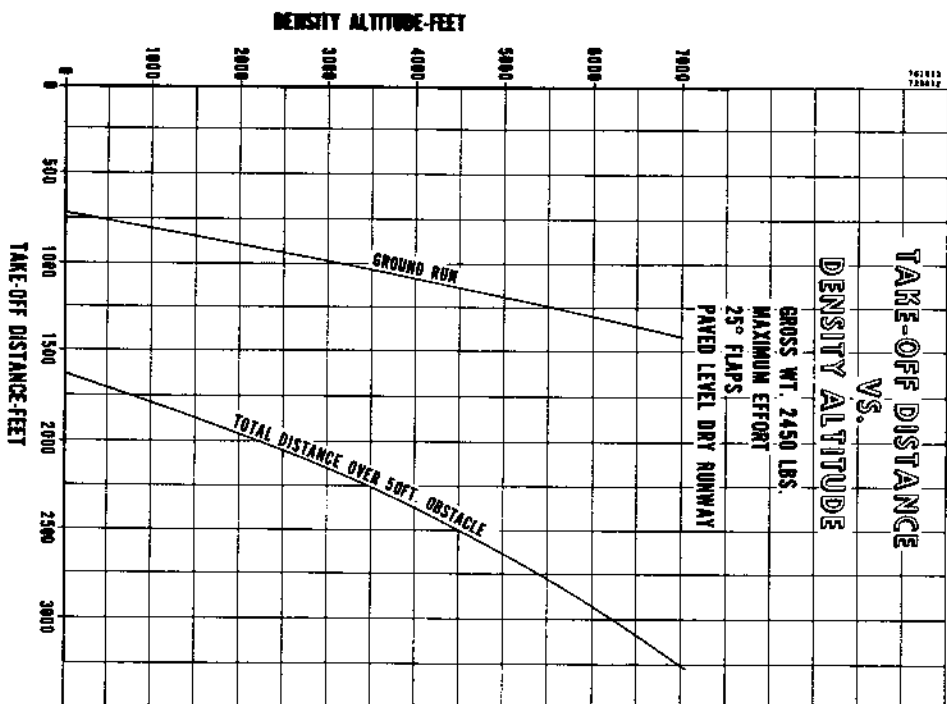

761 513  
730122

# PA-28-180 PIPER CHEROKEE

## ALTITUDE CONVERSION CHART

THIS CHART SHOULD BE USED TO DETERMINE DENSITY ALTITUDE FROM EXISTING TEMPERATURE AND PRESSURE ALTITUDE CONDITIONS FOR USE WITH PERFORMANCE CHARTS.

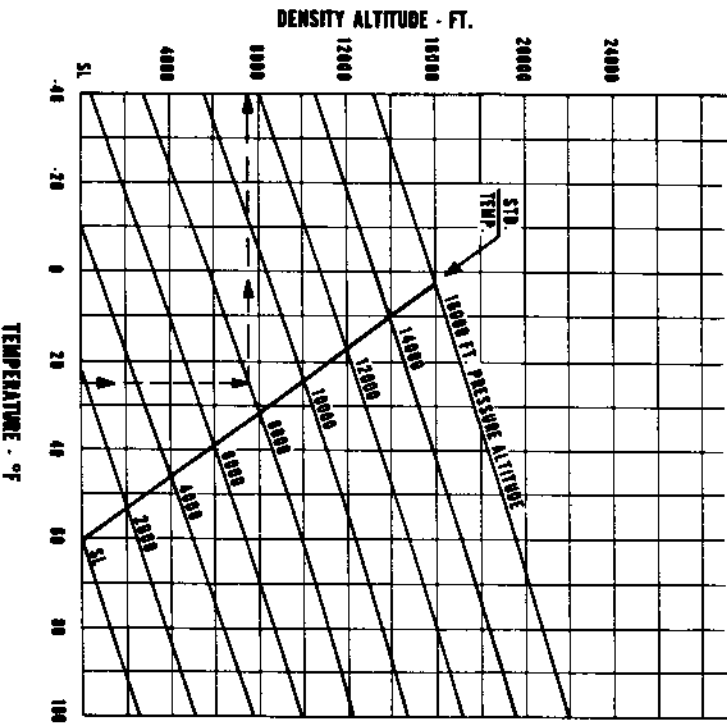

# PA-28-180 PIPER CHEROKEE

## DENSITY ALTITUDE VS. RATE OF CLIMB

TAKE-OFF GROSS WT. 2450 LBS.  
WHEEL FAIRINGS ON

LEARNED TO BEST POWER

FULL MACH

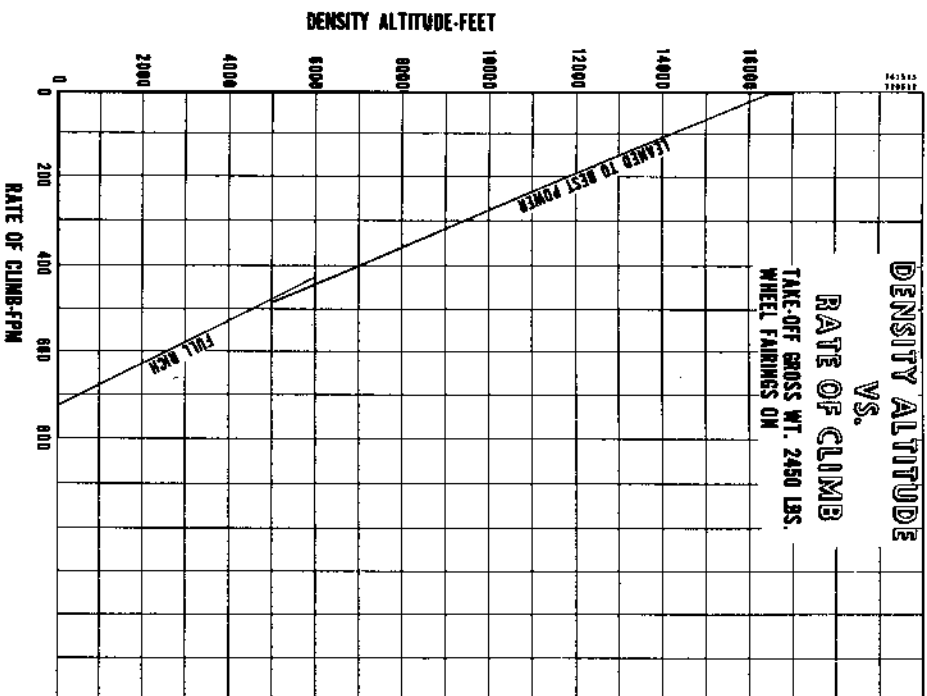

(SEE SECTION III FOR EFFECTS OF AIR CONDITIONER INSTALLATION ON RATE OF CLIMB)

# PA-28-180 PIPER CHEROKEE

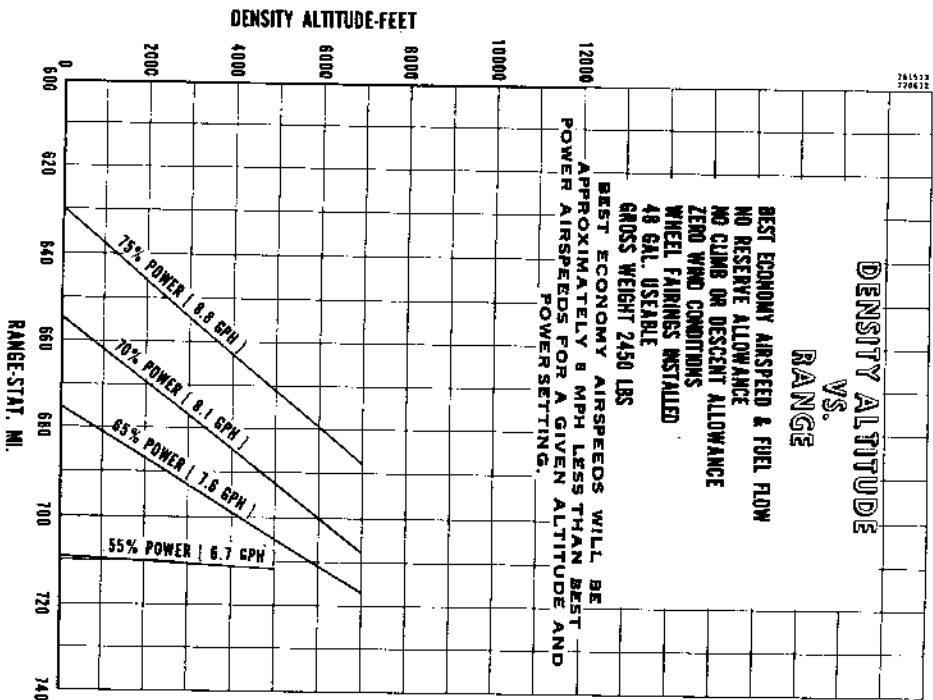

(SEE SECTION III FOR EFFECTS OF AIR CONDITIONER INSTALLATION ON RANGE)

# PA-28-180 PIPER CHEROKEE

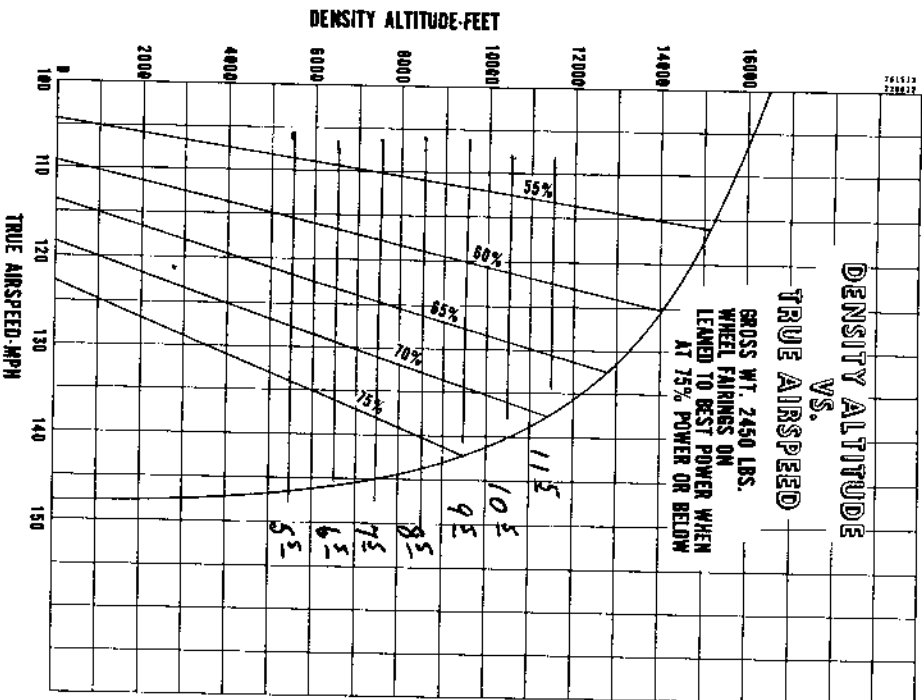

(SEE SECTION III FOR EFFECTS OF AIR CONDITIONER INSTALLATION ON CRUISE SPEEDS)

**PA-28-180  
PIPER CHEROKEE**

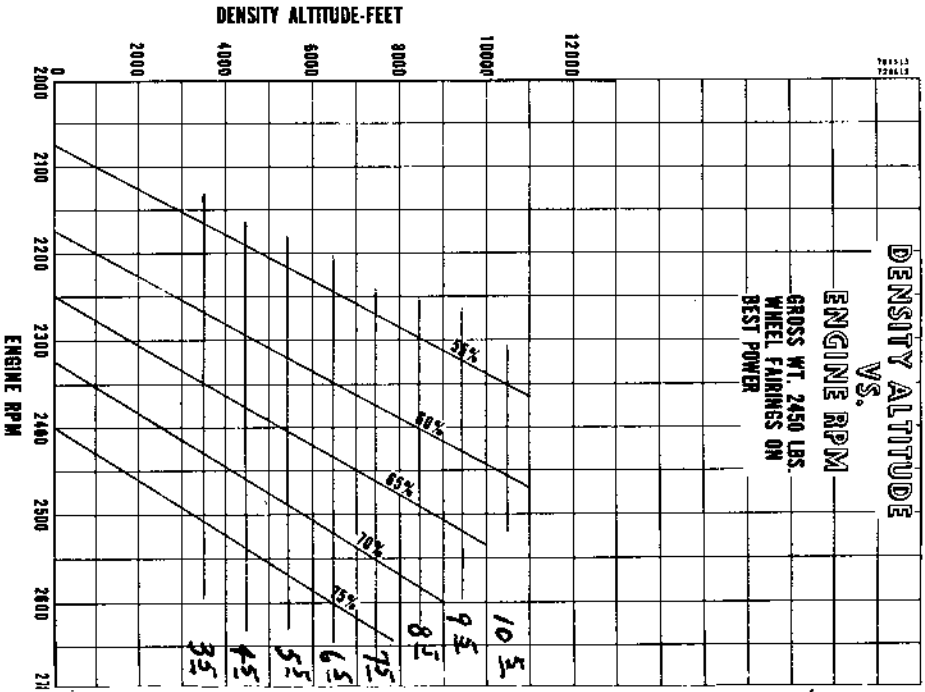

**PA-28-180  
PIPER CHEROKEE**

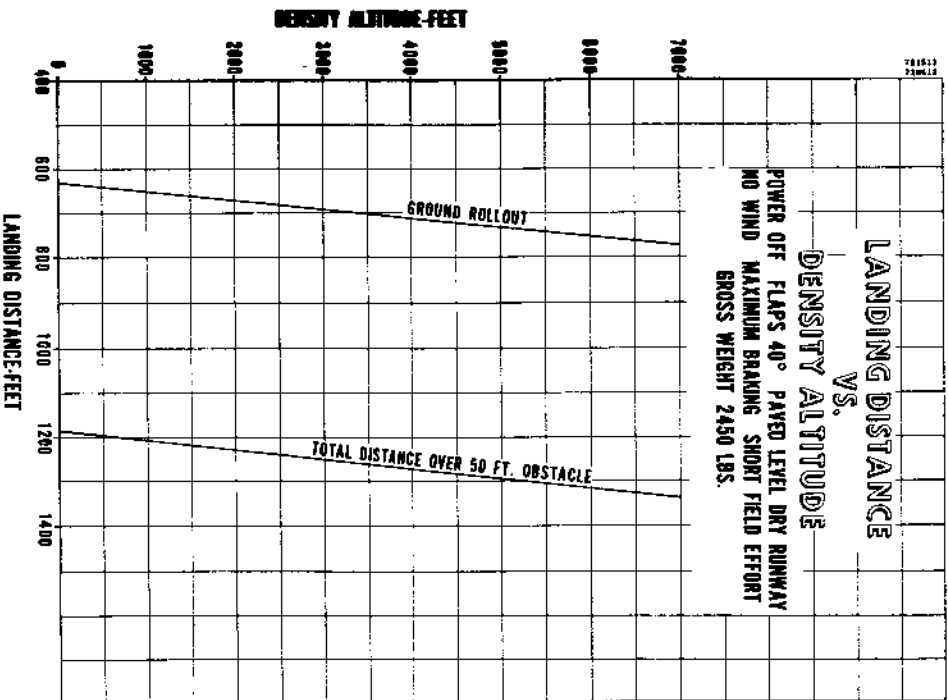

NOTES

SECTION VI

GENERAL MAINTENANCE

Landing Gear Service . . . . .	51
Brake Service . . . . .	53
Tire Inflation . . . . .	53
Care of Windshield and Windows . . . . .	54
Battery Service . . . . .	54
Fuel and Oil Requirements . . . . .	55
Fuel System . . . . .	55
Care of Air Filter . . . . .	55
Leveling and Rigging . . . . .	56
Serial Number Plate . . . . .	57

## SECTION VI

## GENERAL MAINTENANCE

This section of the Cherokee Handbook contains information which pertains to minor maintenance of the airplane. For further maintenance assistance refer to the Service Manual for this airplane. Any complex repairs or modification should be accomplished by a Piper Certified Service Center or equivalent.

## LANDING GEAR SERVICE

The main wheels are Cleveland Aircraft Products, Model # 40-86, with Cleveland single disk hydraulic brake assemblies, Model # 30-55. The nose wheel is a Cleveland Aircraft Products, Model # 40-76B. All wheels use a 6.00 x 6, four ply rating, Type III tire with tube.

Main wheels are easily removed by taking off the hub cap, axle nut, and the two bolts holding the brake segment in place, after which the wheel slips easily from the axle.

Tires are demounted from the wheels by deflating the tire, removing the three through-bolts, and separating the wheel halves.

Landing gear oleo struts should be checked for proper strut exposures and fluid leaks. The required extensions for the strut when under normal static load (empty weight of airplane plus full fuel and oil) is 3.25 inches for the nose gear and 4.50 inches for the main gear. Should the strut exposure be below that required, it should be determined whether air or oil is required by first raising the airplane on jacks. Depress the valve core to allow air to escape from the strut housing chamber. Remove the filler plug and slowly raise the strut to full compression. If the strut has sufficient fluid it will be visible up to the bottom of the filler plug hole and will then only require proper inflation.

## SECTION VI

### CHEROKEE 180

Should fluid be below the bottom of the filler plug hole, oil should be added. Replace the plug with valve core removed, attach a clear plastic hose to the valve strut of the filler plug and submerge the other end in a container of hydraulic fluid (MIL-H-5606). Fully compress and extend the strut several times thus drawing fluid from the container and expelling air from the strut chamber. To allow the fluid to enter the bottom chamber of the main gear strut housing, the torque link assembly must be disconnected to let the strut be extended a minimum of 10 inches. (The nose gear torque links need not be disconnected.) Do not allow the strut to extend more than 12 inches. When air bubbles cease to flow through the hose, compress the strut fully and again check fluid level. Reinstall the valve core and filler plug, and the main gear torque links, if disconnected.

With fluid in the strut housing at the correct level, attach a strut pump to the air valve and with the airplane on the ground, inflate the oleo strut to the correct height.

In jacking the Cherokee for landing gear or other service, a jack kit (available through Piper Dealers or Distributors) should be used. This kit consists of two hydraulic jacks and a tail stand. At least 250 pounds of ballast should be placed on the base of the tail stand before the airplane is jacked up. The hydraulic jacks should be placed under the jack points on the bottom of the wing and the airplane jacked up until the tail skid is at the right height to attach the tail stand. After attaching the tail stand and adding the ballast, the jacking may be continued until the aircraft is at the height desired.

The steering arms from the rudder pedals to the nose wheel are adjusted at the rudder pedals or at the nose wheel by turning in or out the threaded rod end bearings. Adjustment is normally accomplished at the forward end of the rods and should be done in such a way that the nose wheel is in line with the fore and aft axis of the plane when the rudder pedals and rudder are centered. Alignment of the nose wheel can be checked by pushing the airplane back and forth with the rudder centered to determine that the plane follows a perfectly straight line. The turning arc of the nose wheel is 22 degrees in either direction and factory adjusted at stops on the bottom of the forging. The turning radius of the nose wheel is 17 feet.

## CHEROKEE 180

## SECTION VI

The steering arm stops should be carefully adjusted so that the nose wheel reaches its full travel just after the rudder hits its stops. This guarantees that the rudder will be allowed to move through its full travel.

### BRAKE SERVICE

The brake system is filled with MIL-H-5606 (Petroleum base) hydraulic brake fluid. This should be checked at every 50 hour inspection and replenished when necessary by filling the brake reservoir on the upper left front side of the firewall to the indicated level. If the system as a whole has to be refilled with fluid it should be done from the brake end of the system by filling with fluid under pressure. This will eliminate air from the system as it is being filled.

No adjustment of brake clearances is necessary on the Cherokee brakes. If after extended service the brake blocks become worn excessively, they are easily replaced with new segments.

### TIRE INFLATION

For maximum service from the tires on the Cherokee, keep the tires inflated to the proper pressure of 24 pounds for all three wheels. Interchange the tires on the main wheels if necessary to produce even wear. All wheels and tires are balanced before original installation, and the relationship of the tire, tube, and wheel should be maintained if at all possible. Unbalanced wheels can cause extreme vibration on take-off. In the installation of new components it may be necessary to rebalance the wheel with the tire mounted.



## SECTION VI

## CHEROKEE 180

### CARE OF WINDSHIELD AND WINDOWS

A certain amount of care is needed to keep the plexiglas windows clean and unmarred. The following procedure is recommended:

1. Flush with clean water and dislodge excess dirt, mud, etc. with your hand.
2. Wash with mild soap and water or Piper Plastic Cleaner. Use a soft cloth or sponge. Do not rub.
3. Remove oil, grease or sealing compounds with a soft cloth and kerosene.
4. After cleaning, apply a thin coat of hard polishing wax. Rub lightly with a soft cloth.
5. A severe scratch or may may be removed by using jeweler's rouge to rub out the scratch, smoothing, and then applying wax.

### BATTERY SERVICE

Access for service or inspection of the battery is obtained through the removal of the panel at the right rear side of the baggage compartment. The stainless steel box has a plastic drain tube which is normally closed off with a clamp and which should be opened occasionally to drain off any accumulation of liquid. The battery should be checked for proper fluid level, but must not be filled above the baffle plates. Use only water - no acid. A hydrometer check should be performed to determine the percent of charge present in the battery.

If the battery is not up to charge, recharge starting at a 4 ampere rate and finishing with a 2 ampere rate. Quick charges are not recommended.

## CHEROKEE 180

## SECTION VI

### FUEL AND OIL REQUIREMENTS

Aviation Grade 100/130 Octane (minimum) fuel must be used in the Cherokee. Because the use of lower grades can cause serious damage in a very short period of time, the engine warranty is invalidated by such use.

The oil capacity of the Lycoming O-360-A4A is 8 quarts, and the minimum safe quantity is 2 quarts. It is recommended that the oil and oil filter be changed every 50 hours, or sooner under unfavorable conditions. The following grades are recommended for the specific temperatures:

Temperatures above 60° F	S.A.E. 50
Temperatures between 30° and 90° F	S.A.E. 40
Temperatures between 0° and 70° F	S.A.E. 30
Temperatures below 10° F	S.A.E. 20

### FUEL SYSTEM

The fuel screen in the strainer will require cleaning every 50 hour inspection. The strainer, located ahead of the firewall, is accessible for cleaning by removal of the lower cowl. When the strainer is reassembled after cleaning, a small amount of grease applied to the gasket will facilitate assembly.

### CARE OF AIR FILTER

The carburetor air filter must be cleaned at least once every fifty hours. Under extremely adverse conditions of operation it may be necessary to clean the filter daily. Extra filters are inexpensive and a spare should be kept on hand and used as a rapid replacement.

The filter manufacturer recommends that the filter be tapped gently to remove dirt particles. Do not blow out with compressed air.

For extreme cases of wing heaviness, the flap on the wing heavy side may be adjusted down from the zero position as desired. The service manual should be consulted for the proper method of adjusting surface travels.

**SERIAL NUMBER PLATE**

The serial number plate is located near the stabilator on the left side of the airplane. Refer to this number for service or warranty matters.

**SECTION VI**

**CHEROKEE 180**

**LEVELLING AND RIGGING**

Leveling the Cherokee "P" for purposes of weighing or rigging is accomplished as follows:

1. Partially withdraw two machine screws located immediately below the left front side window. These screws are leveling points, and the airplane is longitudinally level when a level placed on the heads of these screws indicates level.
2. To put the airplane in a longitudinally level position on scales, first block the main gear oleos in the fully extended position, then deflate the nose wheel tire until the proper attitude is obtained. For rigging only, the airplane may be placed on jacks for leveling.
3. To level the airplane laterally, place a level across the baggage compartment floor along the rear bulkhead.

Rigging: Although the fixed flight surfaces on the Cherokee cannot be adjusted for rigging purposes, it may be necessary upon occasion to check the position of these surfaces. The movable surfaces all have adjustable stops, as well as adjustable turnbuckles on the cables or push-pull tubes, so that their range of travel can be altered. The positions and angular travels of the various surfaces are as follows:

1. Wings: 7° dihedral, 2° washout.
2. Stabilator Travel: 14° up, 2° down, tolerance  $\pm 1^\circ$ .
3. Fin should be vertical and in line with center of fuselage.
4. Aileron Travel: 30° up, 15° down, tolerance  $\pm 2^\circ$ .
5. Flap Travel: 10°, 25°, 40°, tolerance  $\pm 2^\circ$ .
6. Rudder Travel: 27° right and left, tolerance  $\pm 2^\circ$ .
7. Stabilator Tab Travel: 3° up, 12° down, tolerance  $\pm 1^\circ$ .

Cable tensions for the various controls are as follows:

- |                        |                               |
|------------------------|-------------------------------|
| Rudder: 40 $\pm 5$ #   | Stabilator: 40 $\pm 5$ #      |
| Ailerons: 40 $\pm 5$ # | Stabilator Trim: 10 $\pm 1$ # |
| Flaps: Approx. 10 #    |                               |

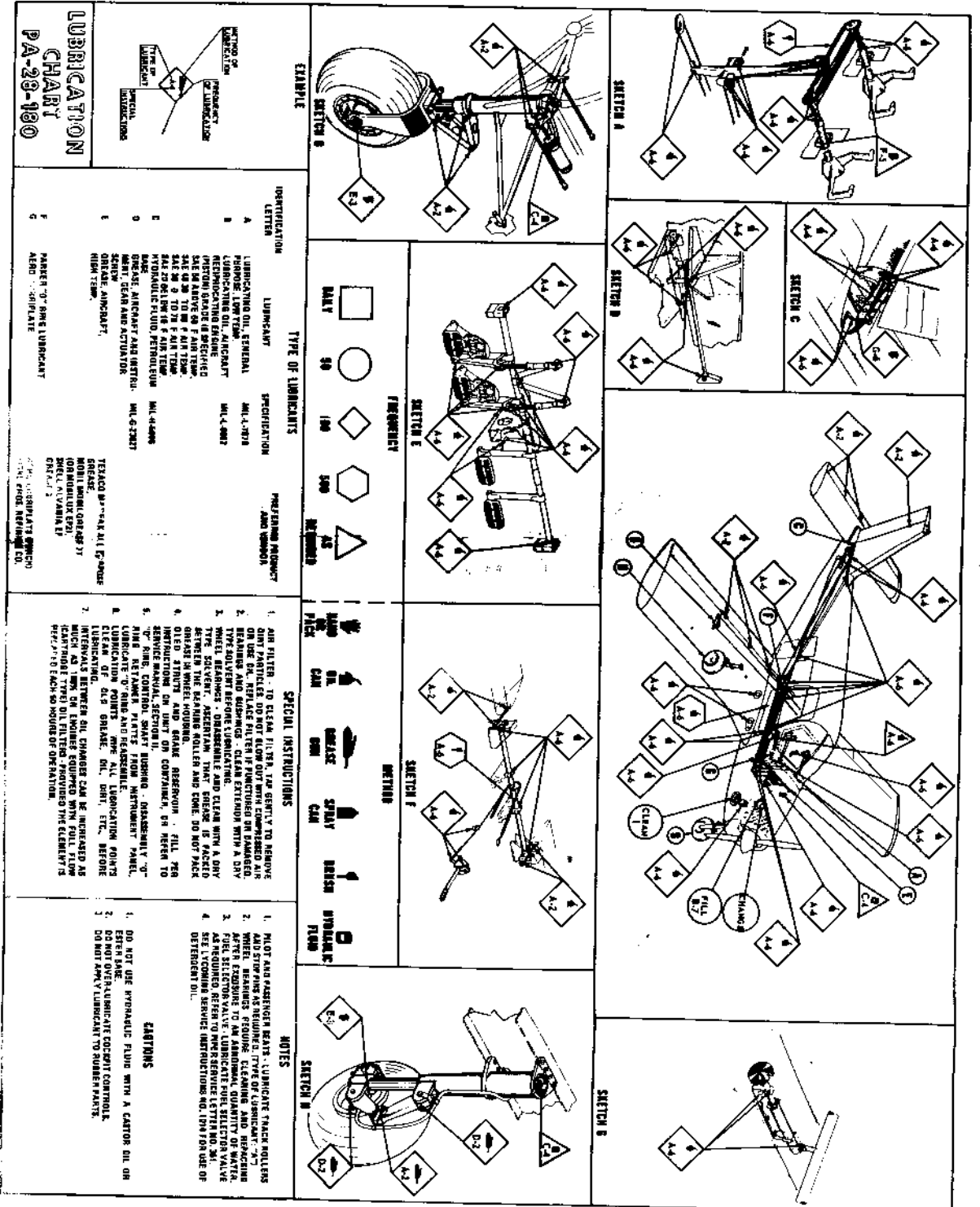

761 513  
720615